

Square Grooming Table with Accessory Arms

Models:

DOG01-PP-00-000

DOG02-PP-00-000

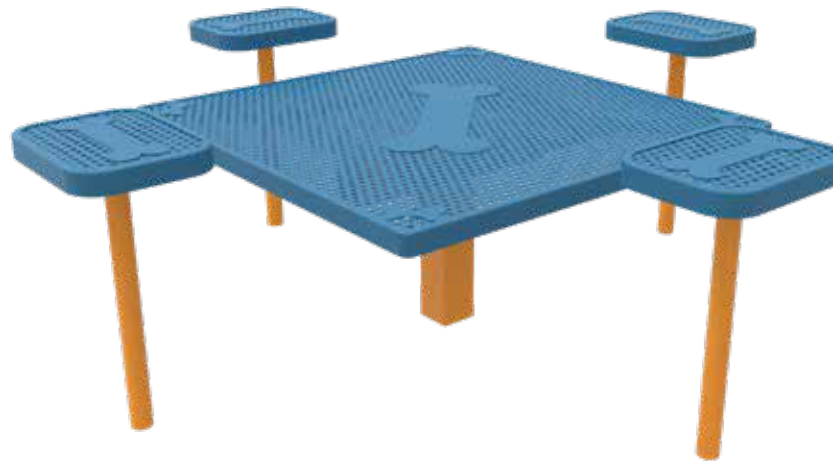

Parts, Hardware, and Suggested Tools

Grooming Table

Unit	Common Description	Units Per Model
GroomingTable	Top	1
Inground	Frame	1
5/16-18	x 1 1/2" tap bolt w/black xylan	4
5/16-18	nylock nut w/black xylan	4
5/16	ussflat washerw/black ox	8
#vc300-85	1/16" bolt size 1/2" lg vinyl cap	4

AccessorieArm

Unit	Common Description	Units Per Model
AccessorieArm	Top	1
Inground	Frame	1
5/16-18	x 1 1/2" tap bolt w/black xylan	4
5/16-18	nylock nut w/black xylan	4
5/16	ussflat washerw/black ox	8
#vc300-85	1/16" bolt size 1/2" lg vinyl cap	4

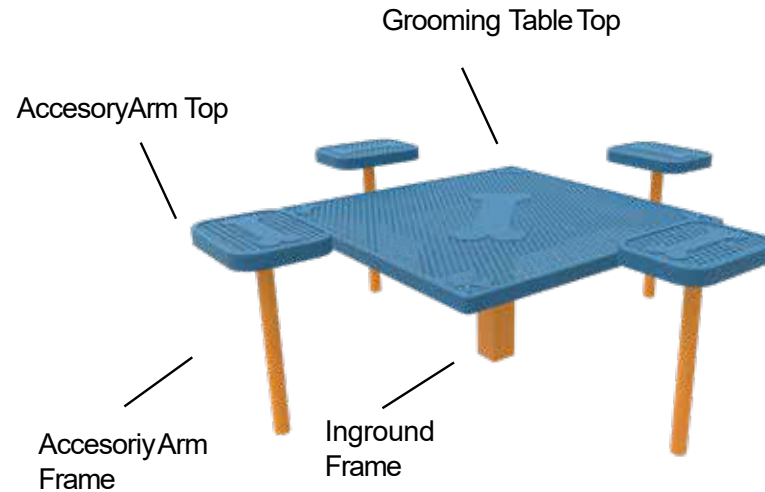

SuggestedTools



Open Face Wrench









Socket Wrench



Tape Measure



Level

-  Bolt (HW01)
-  Frame Bolt (HW06)
-  Frame Nut (HW07)
-  Nut (HW02)
-  Washer (HW03)
-  Bolt Cap (HW04)

Specification - Written

Grooming Table Top and Accessory Top Material: Outer frame is made from 3/4" x 2" rolled form angle iron.

- Punched Steel models- Inside material is 12 gauge, 1/2" punched Steel. Bracing is 1-1/2" Solid Steel flat bar. All MIG welded.

Grooming Table Top and Accessory Top Coating:

- PawProtect Industry Standard Coating - the Industry Standard line is coated with a Premium Polyethylene Coating, The Industry Standard coating comes with a 5 year warranty and is available in 9 different colors with a rough coat to prevent slipping and to protect dog paws.

Grooming Table Frames: Frames are made from 4" square pre-galvanized steel tubing.

Accessory Arm Frame: 2" Round Tubing, pre-galvanized steel tubing.

Frame Coating: High Durability Architectural Grade electrostatic applied Powder Coat.

Hardware: All hardware is Xylan coating black hardware for extra protection and strength

Specification - Drawing

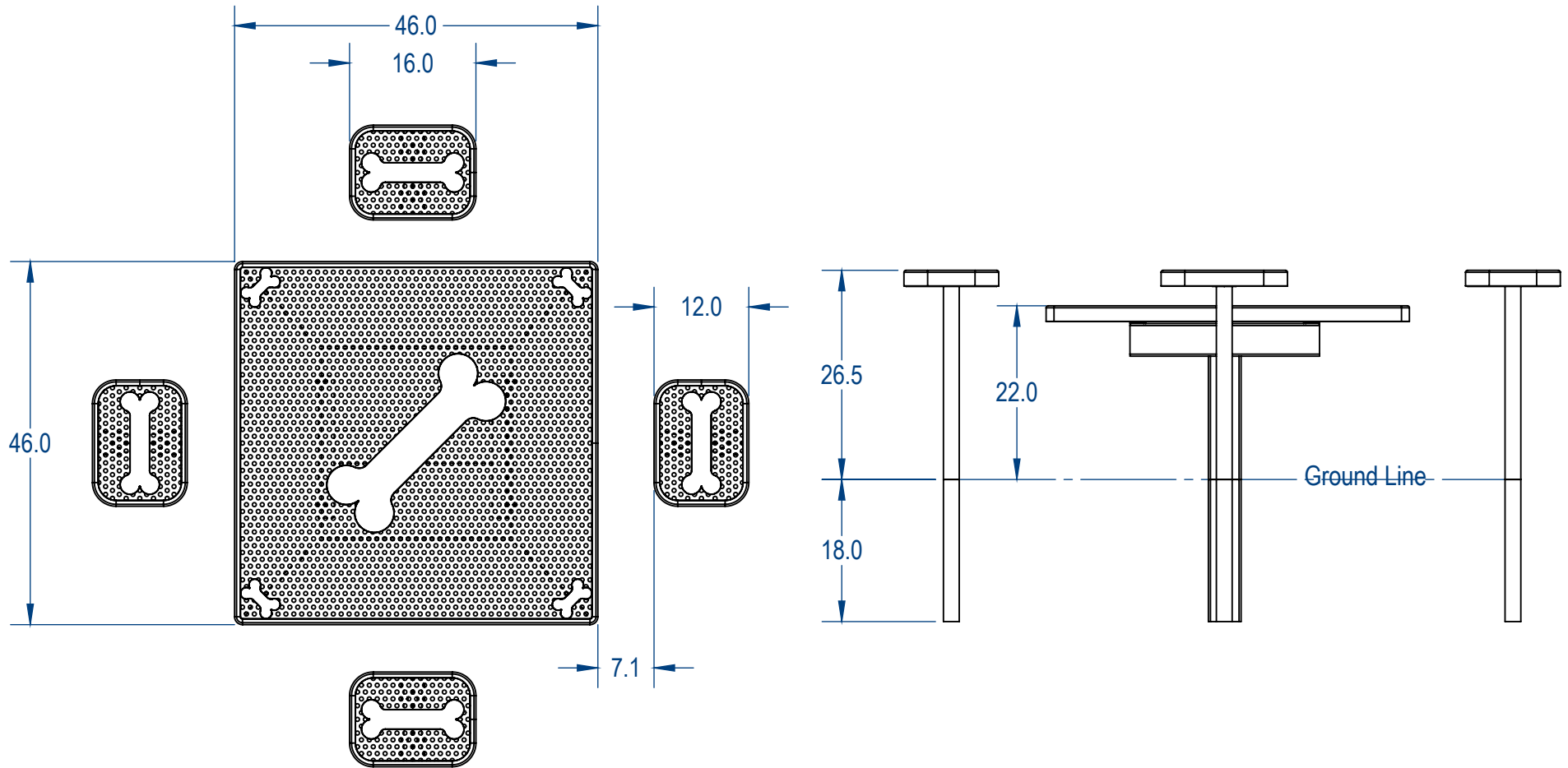

Assembly Instructions

Grooming Table

1. Attached Grooming Table Top to frame using hardware provided
2. Set Frame in Concrete - Approx. 18". (suggested footing hole 24" x 24" x 24")

AccessorieArm

1. Attached AccessorieArm Top to frame using hardware provided
2. Set Frame in Concrete - Approx. 18". (suggested footing hole 12" x 12" x 24")

MyTCoat doesnot offer installation: Recommenda professionalInstaller to install this table.

Installation Safety:

Please Follow Installation Instructions provided by Manufacturer

It is recommended that Product is installed by an experienced installer

Product should be inspected at the time of Delivery, do not install and damaged on defective parts or products.

All Hardware for proper assembly (not installation) is provided. Use hardware that is included with this product.

Product Maintenance:

Maintenance inspection should be performed at a minimum of once a year.

Cleaning, when necessary can be performed with warm water and most household cleaners, avoid any harsh chemicals such as paint remover and acetone. Contact Manufacturer before cleaning to determine if cleaning product is OK for use.

Any surface rust that may occur should be removed and repainted. Contact Manufacturer for touch up paint or any other recommended paints.

Contact Manufacturer for instructions on removing vandalism such as spray paint.

In the case that the MyTCoat coating is damaged, contact Manufacturer for instructions for repair.

Bolts and nuts should be checked on a regular basis to maintain proper tightness.