

HEXAGON HIP SHADE

26' x 26' x 8'

MODEL #:
 HD262608SG (With Glide Elbows)
 HD262608SN (Without Glide Elbows)

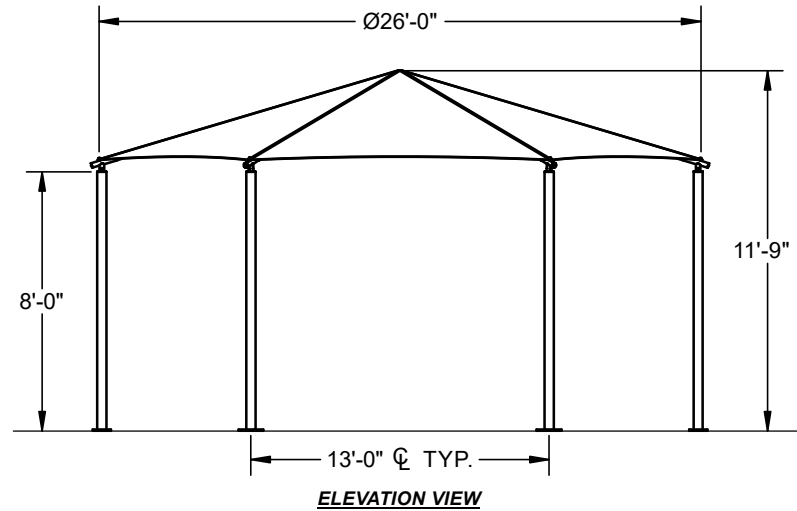

REF.#	PART DESCRIPTION	QTY.
1	Ø5.0"Column - Surface Mount	6
2	Ø5.0"Hub - With Six Sockets	1
3	Ø2.88"Rafter - Swaged	6
4	Angled Elbow	6
5	Fabric - With Cable Insert	1
6	Frame Hardware Kit	1

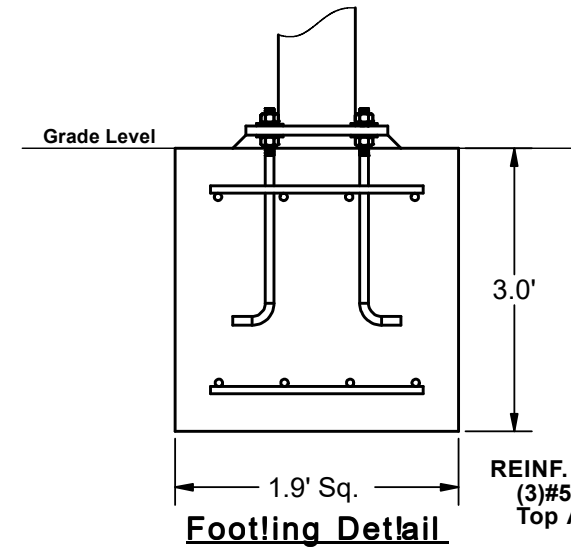

REINF.
 (3)#5 EW
 Top And Bottom

*Footing design based on 1500 PSF soil bearing pressure.

HEXAGON HIP SHADE

26' x 26' x 8'

MODEL #:
 HD262608IG (With Glide Elbows)
 HD262608IN (Without Glide Elbows)

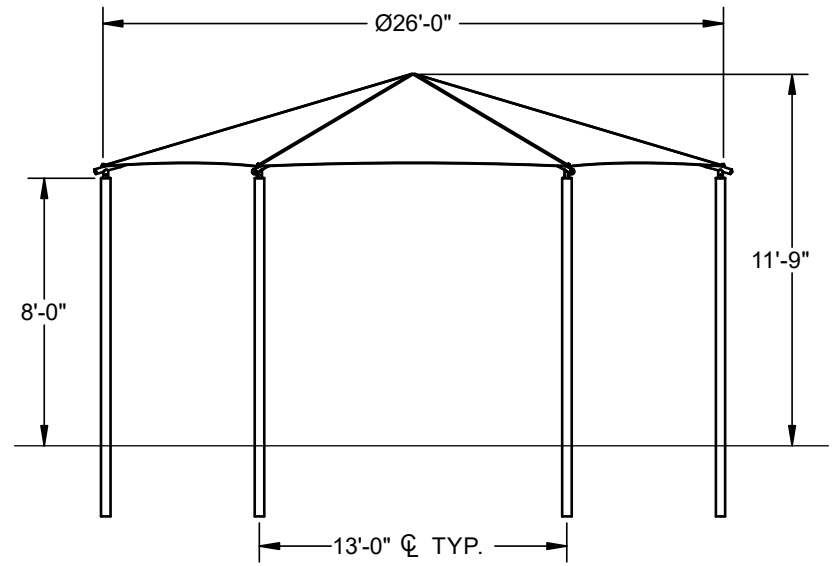

ELEVATION VIEW

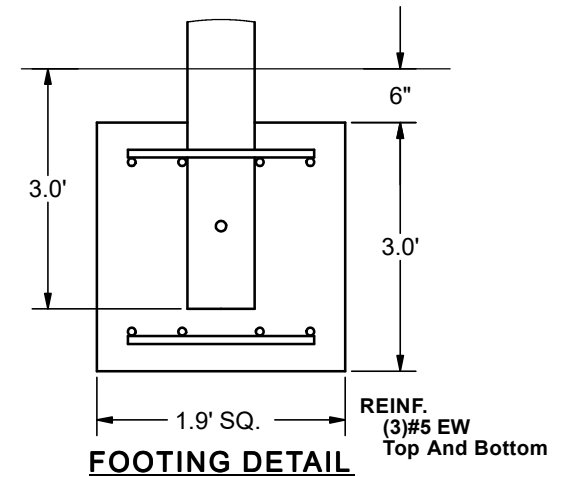

FOOTING DETAIL

*Footing design based on 1500 PSF soil bearing pressure.

REF.#	PART DESCRIPTION	QTY.
1	Ø5.0"Column - Embedded	6
2	Ø5.0"Hub - With Six Sockets	1
3	Ø2.88"Rafter - Swaged	6
4	Angled Elbow	6
5	Fabric - With Cable Insert	1
6	Frame Hardware Kit	1



Furniture Leisure

Commercial Site Furnishings

1-800-213-2401 | sales@furnitureleisure.com

FurnitureLeisure.com PoolFurnitureSupply.com

PicnicFurniture.com PicnicTableSupplier.com

ParkTables.com

UBrace.com