

Lakeland 28in Tall Planter Model # 5868

MIS076



PACKAGE CONTENTS: 1x Lakeland Tall Planter, Removable Tray

MATERIAL: Polyethylene

IMPORTANT NOTE:

- Drainage holes are not included and can be drilled in the desired location depending on the intended use of the planter. See instructions on the reverse side for more details.
- Mayne planters are very durable but we still recommend lightweight fillers and potting mixes for optimal plant growth.

In the event of missing or defective parts, please email customerservice@gomayne.com or call our customer service department toll free at 866-363-8834 (available Monday through Friday, 8am-5pm EST).

General Information:

- Read instructions carefully before beginning assembly.
- To clean the product: For best results use a soap solution and high-pressure water.
- On the reverse side of this instruction sheet there are a few potting recommendations, but please consult your local garden centre or landscape horticulturist for more detailed information.
- All-weather planters molded with high quality polyethylene and designed for year-round use.
- 15-year warranty for residential use.

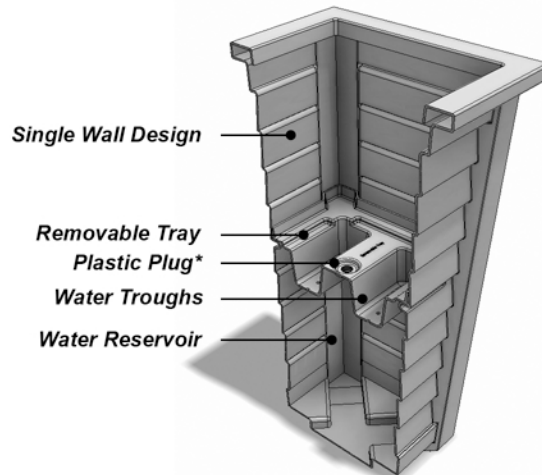
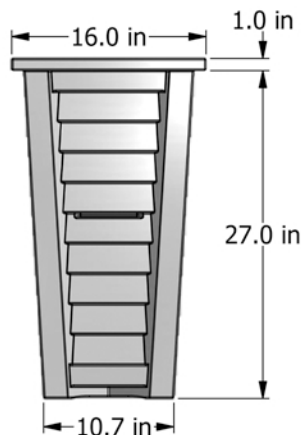
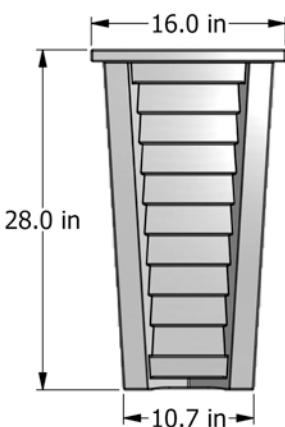
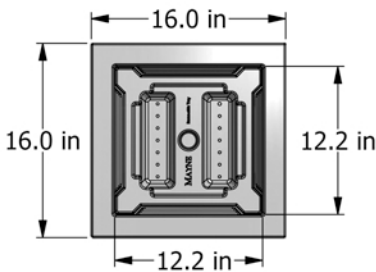

Soil Capacity: 7.4 gallons
Water Reservoir Capacity: 6.7 gallons

* The plastic plug is placed in the center of the tray to seal a vent hole from the manufacturing process. There is no need to remove this plug.

MAYNE[®]
Outdoor Products of Distinction
www.gomayne.com

Drainage Holes:

Depending on the intended use of the planter, drainage holes need to be drilled in different locations.

Option #1:

To utilize the water trough system and create a self watering effect we recommend drilling a hole half way down the planter. A divot marks the location. This allows the planter to maintain the ideal amount of water to keep the plant roots moist and avoid oversaturation of the soil. When you place the planter on your patio face the drain hole to the back so it is out of view.

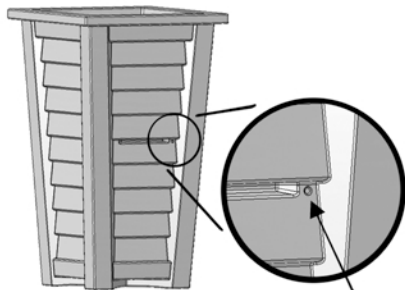

6.3 mm (1/4 in) drainage hole

Option #2:

To use the planter as a regular container planter simply drill one or two holes in the bottom of the planter to allow for drainage. This option is also recommended if you choose to place a potted plant or hanging basket in the Lakeland Tall planter.

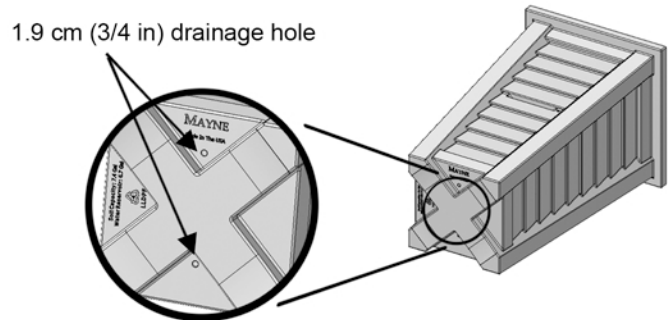

General Recommendations:

To maximize the efficiency of the sub-irrigation system and encourage healthy plant growth we recommend the following:

- 1) Ensure the water reservoir tray insert is seated firmly in the planter.
- 2) Add a layer of lightweight filler to the bottom of the tray. Some suggestions for lightweight fillers include lava rock, mulch, wood chips, or foam packing peanuts (don't use foam packing peanuts if you are growing edible plants).
- 3) Top up the planter with a potting mix (not garden soil) containing peat moss, perlite or vermiculite. Many gardeners have found "soil-less" potting mixes promote stronger root growth.
- 4) Water as you needed for the next few weeks allowing the reservoir to fill up with water.

Sub-Irrigation System

The Lakeland Tall planter includes a water trough insert creating a reservoir at the bottom of the planter. Capillary action allows water in the reservoir to soak upward, keeping the soil and plant roots moist. To avoid oversaturation a hole is located in the side of the planter to allow excess water to drain freely from the reservoir. Regular watering is required for the first few weeks giving the root system time to develop. Please note that due to the height of the planter, the root system on some plants may not fully reach the water trough so regular watering may be required for a longer period of time.

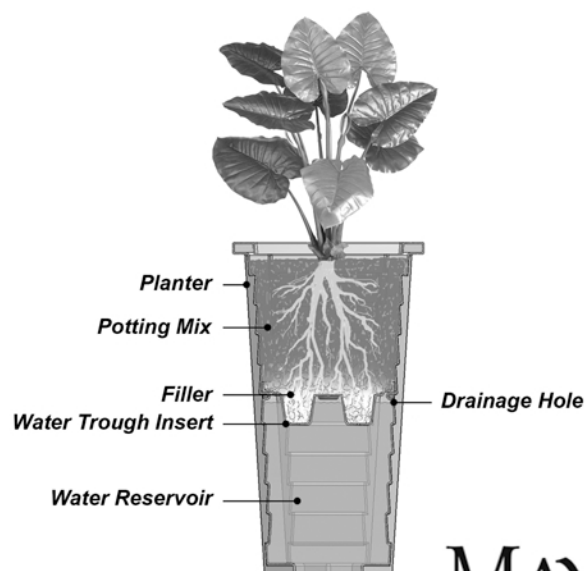

NOTE: The information above is only suggested and Mayne holds no liability for the condition or growth of your plants.